

SOT-23 Plastic-Encapsulate Diodes

MMBD7000 SWITCHING DIODE

FEATURES

- Dual Switching Diode
- Fast Switching Speed
- Surface Mount Package Ideally Suited for Automatic Insertion
- For General Purpose Switching Applications

MARKING:M5C

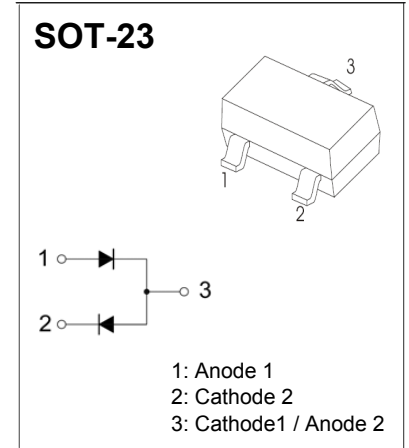
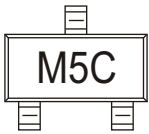

Maximum Ratings @Ta=25°C

Parameter	Symbol	Limits	Unit
Non-Repetitive Peak Reverse Voltage	V_{RM}	100	V
Peak Repetitive Reverse Voltage	V_{RRM}	75	V
Working Peak Reverse Voltage	V_{RWM}		V
RMS Reverse Voltage	$V_{R(RMS)}$	53	V
Average Rectified Output Current	I_O	200	mA
Non-Repetitive Peak Forward Surge Current @ t =8.3ms	I_{FSM}	2	A
Power Dissipation	P_D	225	mW
Thermal Resistance,Junction to Ambient	$R_{\theta JA}$	556	°C/W
Junction temperature	T_j	150	°C
Storage temperature range	T_{STG}	-55~+150	°C

Electrical Characteristics @Ta=25°C

Parameter	Symbol	Test conditions	Min	Max	Unit
Reverse breakdown voltage	$V_{(BR)}$	$I_R=100\mu A$	100		V
Reverse voltage leakage current	I_R	$V_R=50V$ $V_R=100V$		1.0 3.0	μA
Forward voltage	V_F	$I_F=1mA$ $I_F=10mA$ $I_F=100mA$	0.55 0.67 0.75	0.7 0.82 1.1	V
Diode capacitance	C_T	$V_R=0V, f=1.0MHz$		2	pF
Reverse recovery time	t_{rr}	$I_F=I_R=10mA,$ $I_{rr}=0.1 \times I_R, R_L=100\Omega$		4	ns

Typical Characteristics

Forward Characteristics

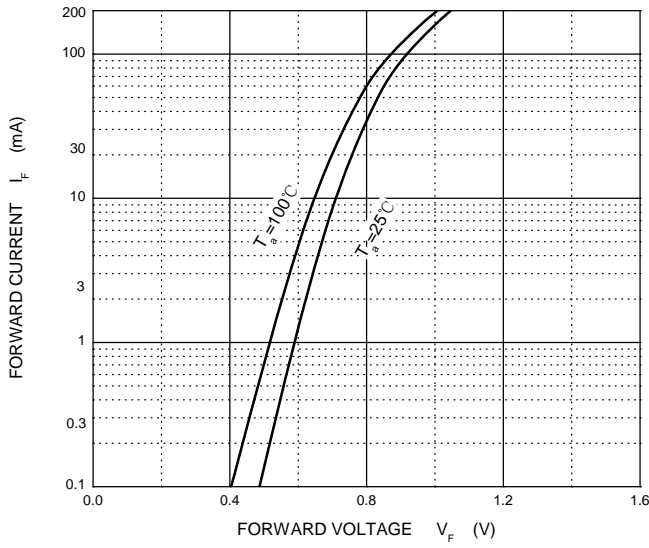

Reverse Characteristics

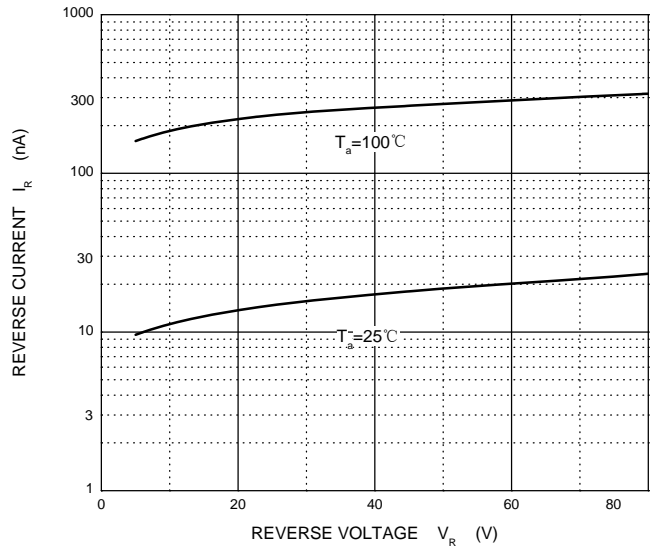

Capacitance Characteristics

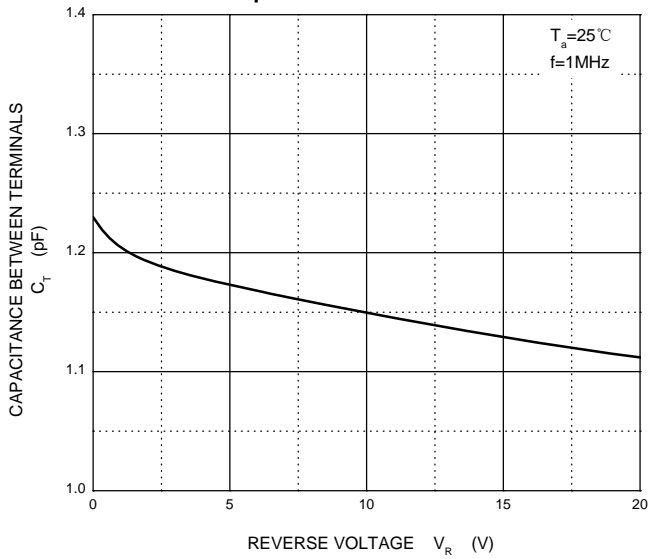

Power Derating Curve

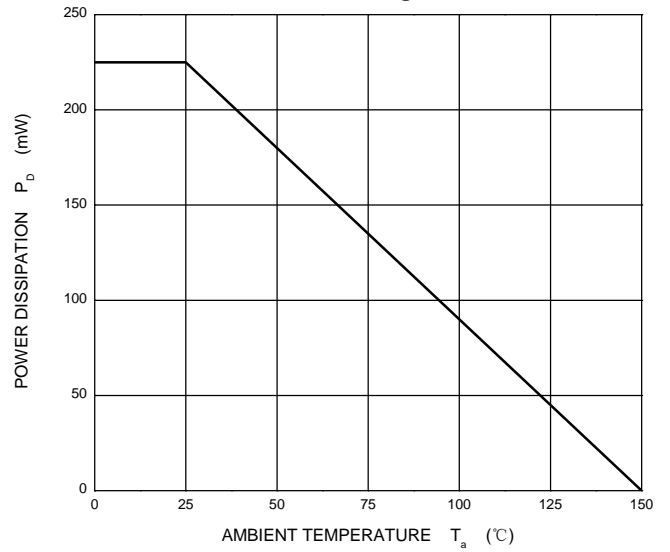

Outlitne Drawing

SOT-23 Package Outline Dimensions

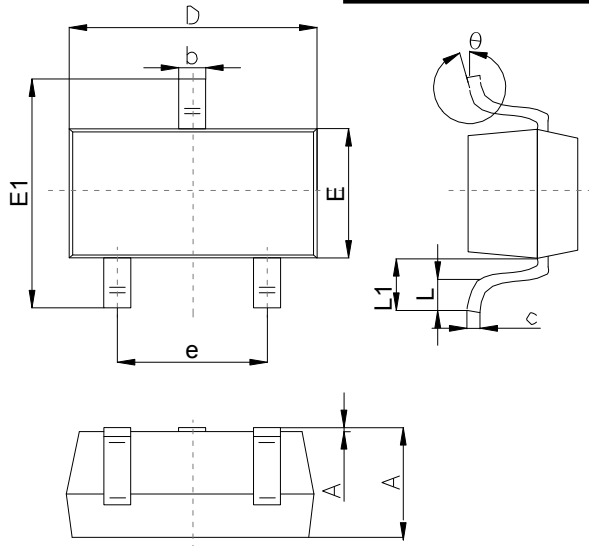

Symbol	Dimensions In Millimeters		
	Min	Typ	Max
A	0.90		1.40
A1	0.00		0.10
b	0.30		0.50
c	0.08		0.20
D	2.80	2.90	3.10
E	1.20		1.60
E1	2.25		2.80
e	1.80	1.90	2.00
L	0.10		0.50
L1	0.4		0.55
θ	0°		10°

Suggested Pad Layout

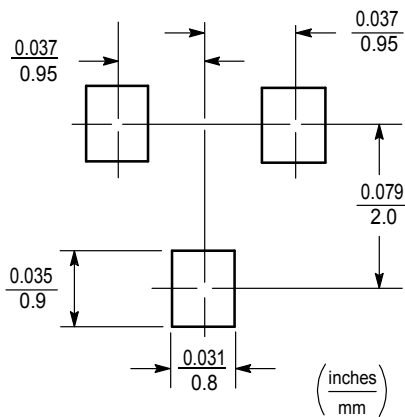

Note:

1. Controlling dimension:in/millimeters.
2. General tolerance: ±0.05mm.
3. The pad layout is for reference purposes only.

SOT-23 Tape and Reel

SOT-23 Embossed Carrier Tape

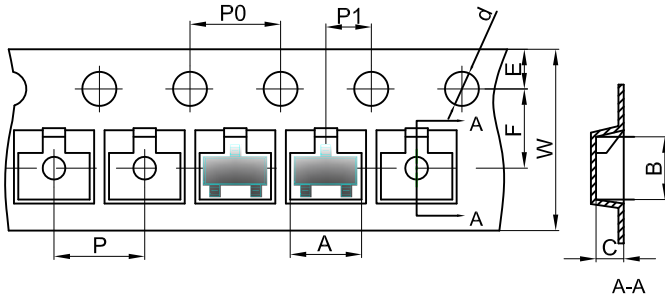

Packaging Description:

SOT-23 parts are shipped in tape. The carrier tape is made from a dissipative (carbon filled) polycarbonate resin. The cover tape is a multilayer film (Heat Activated Adhesive in nature) primarily composed of polyester film, adhesive layer, sealant, and anti-static sprayed agent. These reeled parts in standard option are shipped with 3,000 units per 7" or 17.8cm diameter reel. The reels are clear in color and is made of polystyrene plastic (anti-static coated).

Dimensions are in millimeter										
Pkg type	A	B	C	d	E	F	P0	P	P1	W
SOT-23	3.15	2.77	1.22	Ø1.50	1.75	3.50	4.00	4.00	2.00	8.00

SOT-23 Tape Leader and Trailer

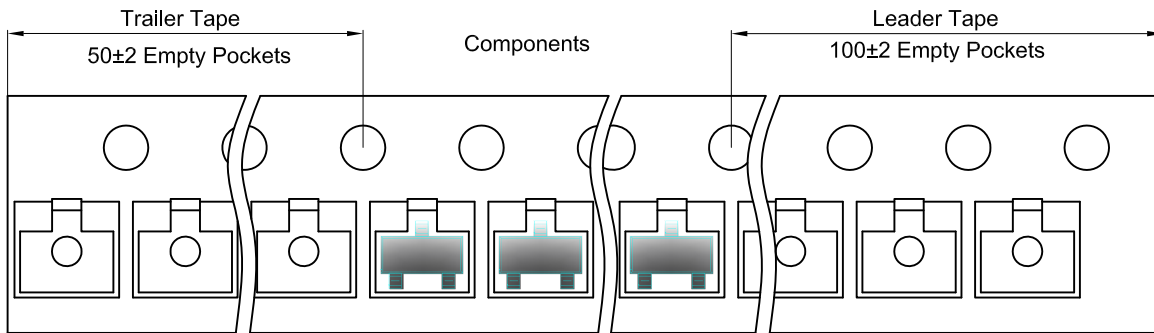

SOT-23 Reel

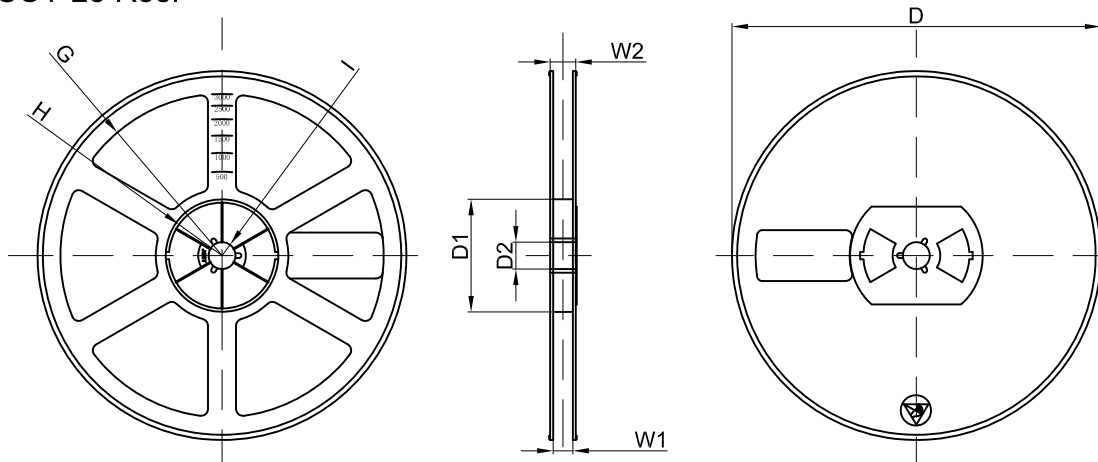

Dimensions are in millimeter								
Reel Option	D	D1	D2	G	H	I	W1	W2
7" Dia	Ø178.00	54.40	13.00	R78.00	R25.60	R6.50	9.50	12.30

REEL	Reel Size	Box	Box Size(mm)	Carton	Carton Size(mm)	G.W.(kg)
3000 pcs	7 Inch	45,000 pcs	203×203×195	180,000 pcs	438×438×220	